



Mitsubishi Electric City Multi systems to Home Automation Application

The Mitsubishi Electric Application has been specially designed to allow bidirectional control and monitoring of Mitsubishi Electric City Multi systems from a Home Automation system.

The solution allows the integration of up to 100 groups from a single Interface.



FEATURES

UL Certified.

Direct access to Central Controller via Ethernet.

Scan: Automatic identification of the units presents on the VRF system.

Outdoor unit's signals available for the integration.

Integration with any IP Home Automation System thanks to our open ASCII protocol.

Compatible with the drivers available at Intesis webpage.

Direct ethernet connection to the home's local IP network.

Up to 6 TCP clients (incoming sockets) are supported.

Configuration through IP or USB (Console) port.

Easy integration with Intesis MAPS.

Automatic updates for both Intesis MAPS and interface's firmware.

Use Case

Integration of Mitsubishi Electric Domestic City Multi units through Central Controller into a Home Automation installation

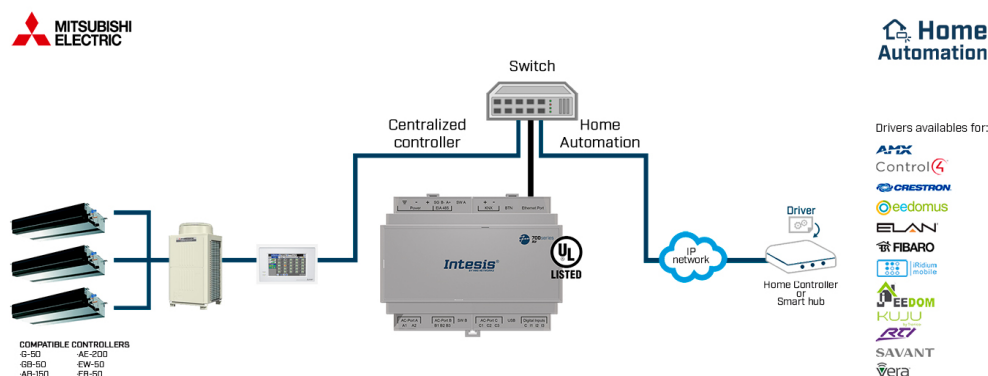

DIRECT CONNECTION TO INDOOR UNITS

The gateway is directly connected to the Central Controller via Ethernet and enables the control of all the indoor units connected to the system.

This allows not only the control and monitoring of the main AC functions but the access to some internal variables of the outdoor units.

UP BY INTESIS MAPS

The configuration is carried out using the Intesis MAPS software. This one allows you to define your own settings for the device and offers extra

functions available for all the new generation gateways. Thanks to the scan function, which allows to automatically discover all the units available in the installation, get the interface ready to work in a really short time.

Intesis MAPS makes it easy to identify any malfunction in the installations thanks to its robust diagnostic feature.

Technical Documentation

User Manual	General information about this product	Download
Installation Manual	Learn how to install the device in your project	Download
Application Wiring Diagram	Review your specific application wiring diagram	Download
HVAC Compatibility tool	Find the appropriate solution for your HVAC integration	Open
Protocol Specifications	This document contains the basis of the WMP protocol	Download
EC Declaration of Conformity	Check the product certification	Download
UKCA Certification	Check the product UKCA Certification	Download
Recommendations to avoid polarity issues	How to avoid polarity issues in RS485 Networks	Learn more







Programming Tools





Intesis MAPS	Get access to download the configuration software tool	Download
Intesis MAPS User Manual	General information about Intesis MAPS	Download
eLearning course	Learn the secrets of Intesis MAPS	Enroll now

Commercial Documentation

Marketing Datasheet	Discover all the integration solutions for Mitsubishi Electric	Download
Intesis Brochure	Know more about the Intesis current available products	Download

Drivers for WMP AC Interfaces

	Intesis - AMX driver	Download
	Intesis - Control 4 driver	Download
	Intesis - Crestron driver	Download
	Intesis Eedomus driver	Download
	Intesis - ELAN driver	Download
	Intesis - FIBARO driver	Download

	Intesis - Iridium driver	Download
	Intesis - Jeedom driver	Download
	Intesis - RTI driver	Download
	Intesis - Savant driver	Download
	Intesis - VERA driver	Download

File	Version	Size	Read online
------	---------	------	-------------

ORDER CODES:

IN770AIR00SO000	Intesis multi-brand AC interface with KNX, Serial and IP support - Up to 50 groups
IN770AIR00MO000	Intesis multi-brand AC interface with KNX, Serial and IP support - Up to 100 groups

The order code can differ depending on the product seller and the buyer's location.

→ For the older version, please click here to find the documentation

INCLUDED COMPONENTS:

- Intesis Gateway.
- Installation Manual.
- USB Configuration cable.
- (Power supply not included).

Warranty: 36 months.

Copyright © 2020 HMS Industrial Networks - All rights reserved.