



## Midea Commercial & VRF systems to Home Automation Application

The Midea Application has been specially designed to allow bidirectional control and monitoring of Midea Commercial & VRF systems from a Home Automation system.

The solution allows the integration of up to 64 indoor units from a single Interface.



### FEATURES

UL Listed.

Direct access to outdoor unit's communication bus.

Scan: Automatic identification of the units presents on the VRF system.

Integration with any IP Home Automation System thanks to our open ASCII protocol.

Compatible with the drivers available at Intesis webpage.

Direct ethernet connection to the home's local IP network.

Up to 6 TCP clients (incoming sockets) are supported.

Configuration through IP or USB (Console) port.

Easy integration with Intesis MAPS.

Automatic updates for both Intesis MAPS and interface's firmware.

### Use Case

#### Integration of Midea Commercial & VRF systems into a Home Automation installation

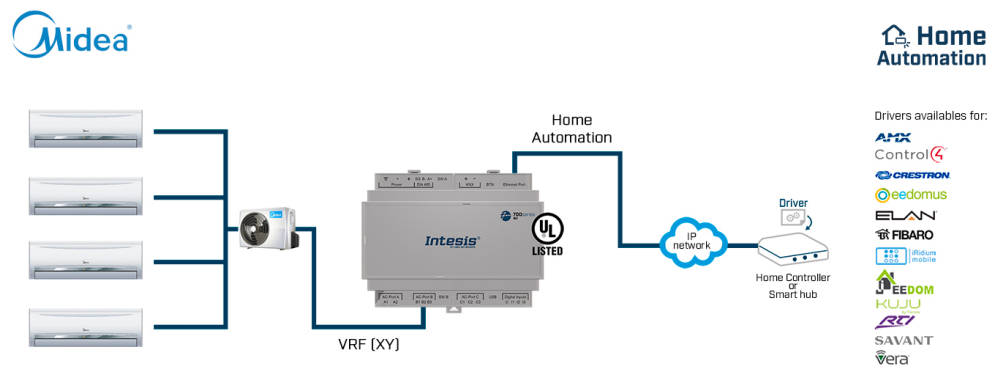

### Description

#### DIRECT CONNECTION TO INDOOR UNITS

The gateway is wired directly to an indoor or outdoor unit. This allows not only the control of the main AC functions such as operating mode, fan speed, temperature setpoint...but the monitoring of errors, alarms and some internal variables.

#### FAST AND EASY TO SET UP BY DIP-SW

This product can be installed and set up in a really short time. It's only a matter of wiring the gateway to the AC unit and configure the DIP-SW accordingly. No configuration software and no power supply are required.

The consistent Modbus register mapping used for all AC brands, helps improving the integration time of each project.

### Technical Documentation

User Manual	General information about this product	Download
Installation Manual	Learn how to install the device in your project	Download
Application Wiring Diagram	Review your specific application wiring diagram	Download
Protocol Specifications	This document contains the basis of the WMP protocol	Download
HVAC Compatibility tool	Find the appropriate solution for your HVAC integration	Open
EC Declaration of Conformity	Check the product certification	Download
UKCA Certification	Check the product UKCA Certification	Download
Recommendations to avoid polarity issues	How to avoid polarity issues in RS485 Networks	Learn more









### Programming Tools



Intesis MAPS	Get access to download the configuration software tool	Download
Intesis MAPS User Manual	General information about Intesis MAPS	Download
eLearning course	Learn the secrets of Intesis MAPS	Enroll now

### Commercial Documentation

Marketing Datasheet	Discover all the integration solutions for Midea	Download
Intesis Brochure	Know more about the Intesis current available products	Download

### Drivers for WMP AC Interfaces

	Intesis - AMX driver	Download
	Intesis - Control 4 driver	Download
	Intesis - Crestron driver	Download
	Intesis Eedomus driver	Download
	Intesis - ELAN driver	Download
	Intesis - FIBARO driver	Download
	Intesis - Iridium driver	Download
	Intesis - Jeedom driver	Download

	Intesis - RTI driver	<a href="#">Download</a>
	Intesis - Savant driver	<a href="#">Download</a>
	Intesis - VERA driver	<a href="#">Download</a>

File	Version	Size	Read online
------	---------	------	-------------

**ORDER CODES:**

IN770AIR00SO000	Intesis multi-brand AC interface with KNX, Serial and IP support - Up to 16 Indoor Units
IN770AIR00MO000	Intesis multi-brand AC interface with KNX, Serial and IP support - Up to 64 Indoor Units

The order code can differ depending on the product seller and the buyer's location.

**INCLUDED COMPONENTS:**

- Intesis Gateway.
- Installation Manual.
- USB Configuration cable.
- (Power supply not included).

Warranty: 36 months.

Copyright © 2020 HMS Industrial Networks - All rights reserved.