

Room Application Controller

MODEL	DESCRIPTION
RAC18-IP	Room Application Controller with a built-in nano EDGE ENGINE

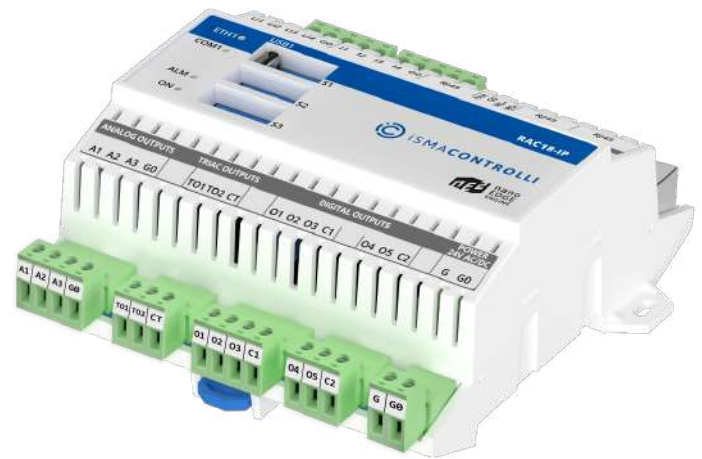

APPLICATION AND USE

The RAC18-IP is a multifunctional device providing comfort in a single room or a zone in the building. 18 onboard I/O's with Ethernet and serial port make the controller a versatile system for comfort management, light and blind control, and integration and monitoring. The RAC18-IP controller has a built-in nano EDGE ENGINE – the cutting-edge software that allows for constructing multiple applications and provides a set of libraries and components tailored to create cycle-driven user applications. This solution provides an automatic BACnet exposure and real-time programming.

Maintenance and programming of the device are possible from anywhere in real time with a dedicated, free-of-charge tool. The RAC18-IP ensures an easy replacement process with a system and applications on a removable SD card.

FEATURES

- Room and zone IP management
- Openness and reliability
- Seamless programming and maintenance
- Built-in nano EDGE ENGINE
- Cycle-driven multithreaded application
- Favorable licensing system
- Reference linking method
- Clear and logical structure
- 150 Data Points
- System and applications on SD card
- 2 fail-safe Ethernet ports with a built-in switch
- Native BACnet IP
- Modbus RTU
- Built-in real-time clock (RTC)
- Support for over 20 types of temperature sensors
- Digital inputs with fast pulse counter
- Triac outputs for thermal actuators

TECHNICAL CHARACTERISTICS

DESCRIPTION		RAC18-IP
Power supply	Voltage	24 V AC/DC \pm 20%
Universal inputs	Number of inputs	4
	Voltage input	Voltage measurement: 0-10 V DC Input impedance: 100 k Ω Measurement accuracy: \pm 0.1% Measurement resolution: 3 mV at 12-bit and 1 mV at 16-bit
	Current input	Current measurement: 0-20 mA Required external resistor: 200 Ω Measurement accuracy: \pm 1.1% Measurement resolution: 15 μ A at 12-bit and 5 μ A at 16-bit
	Digital input	Output current \sim 1 mA

The performances stated in this sheet can be modified without any prior notice.

DESCRIPTION		RAC18-IP
Universal inputs	Resistance input	Measurement of resistance: 0-1000 kΩ Measurement resolution for 20 kΩ load: 20 Ω at 12-bit and 1 Ω at 16-bit Measurement resolution for PT1000 and NI1000: 0.1 Ω at 16-bit Resistance measurement method: voltage divider
	Temperature input	Measurement with RTDS (Real Time Digital Simulator) attached Accuracy: ±0.1°C The PT1000 and NI1000 sensors use 16-bit resolution
	Measurement resolution	12-bit (default), 16-bit
	Processing time	10 ms/channel at 12-bit 140 ms/channel at 16-bit
Digital inputs	Number of inputs	4
	Type	Dry contact or fast pulse counter
	Maximum input frequency	100 Hz saved in EEPROM memory
Analog outputs	Number of outputs	3
	Voltage range	0-10 V DC
	Maximum load current	20 mA
	Resolution	12-bit
	Accuracy	±0.5%
Digital outputs	Number of outputs	5
	Resistive load (AC1)	3 A at 230 V AC or 3 A at 30 V DC
	Inductive load (AC3)	75 VA at 230 V AC or 30 W at 30 V DC
Triac outputs	Number of outputs	2
	Load	0.5 A at 20 V AC up to max. 230 V AC
	Peak load per channel	1.5 A at 20 V AC up to max. 250 V AC (30 s)
	Gate control	Zero crossing turn ON
	Frequency range	47 to 63 Hz
	Snubber	Snubberless triac
COM1	RS485 Interface	Up to 128 devices Half-duplex
	Communication protocol	Modbus RTU
	Ports	RJ45 + screwless connector
	Baud rate	4800-115200
	Power supply for external device	30 V DC
ETH1	Ethernet Interface	2 ports, fail-safe protected
	Baud rate	10/100 Mb/s
USB1	USB 2.0	USB type C
Ingress protection	IP rating	IP 40 for indoor installation
Temperature	Storage	-40°C to +85°C (-40°F to +185°F)
	Operating	0°C to +50°C (32°F to 122°F)
Humidity	Relative	5 to 95% RH (without condensation)
Screw connectors	Type	Removable screw terminals
	Maximum cable size	2.5 mm ² (18...12 AWG)
Screwless connector	Type	Removable screwless terminals
	Maximum cable size	1.5 mm ² (24...16 AWG)
Housing	Material	Self-extinguishing plastic (PC/ABS)
	Mounting	DIN (DIN EN 50022 norm) 2 screw holders
Dimensions	Width	123.3 mm/4.85 in
	Length	136.6 mm/5.38 in
	Height	54.5 mm/2.15 in

Power Supply

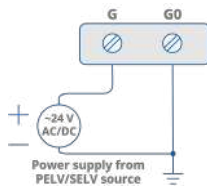

Communication

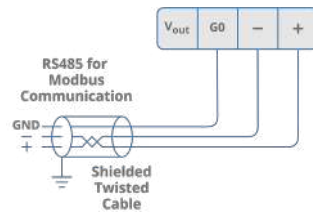

Universal Inputs

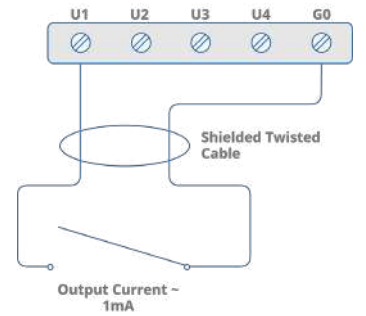
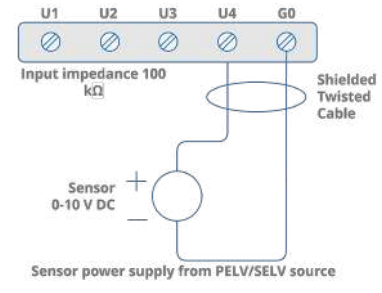
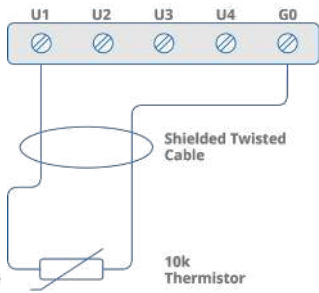
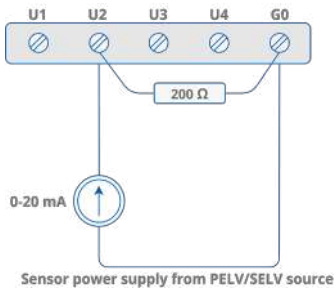

Digital Inputs

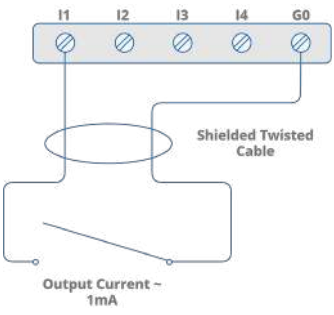

Analog Outputs

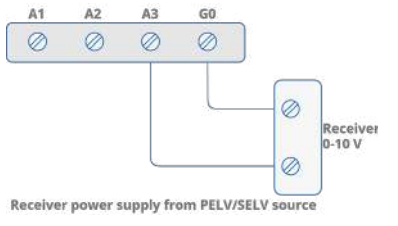
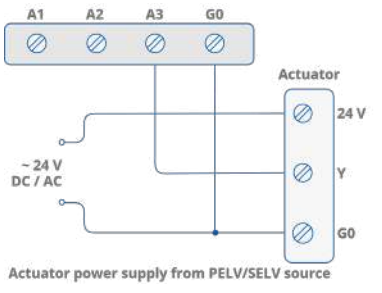
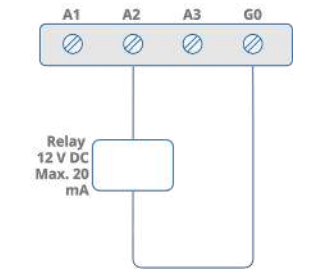

Digital Outputs

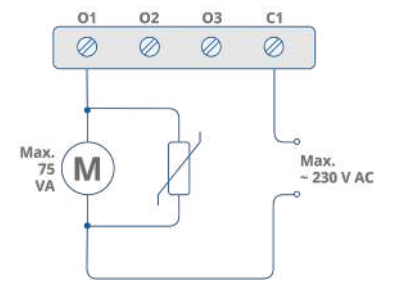
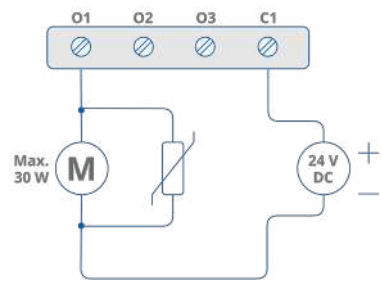
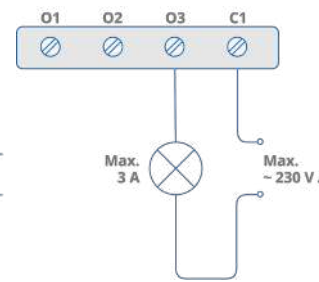
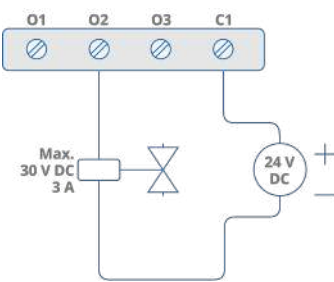

Triac Outputs

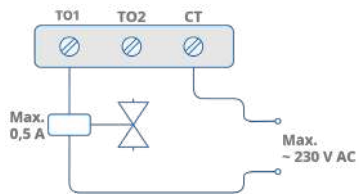

Modbus TCP/IP

BACnet IP

