

IB IL RTD 4/PT1000-ECO

**Inline ECO, temperature measurement terminal,
analog RTD inputs: 4 (Pt 1000)**

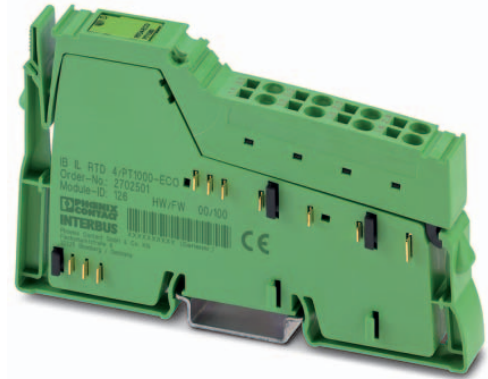

Data sheet
107139_en_00

© PHOENIX CONTACT 2016-10-17

1 Description

The terminal is designed for use within an Inline station. It is used to acquire signals from resistive temperature sensors.

The measured values are depicted in standardized representation format.

Inline ECO terminals are approved for the temperature range from 0°C to +55°C. The electronics base and Inline connector are supplied as standard.

Features

- 4 analog inputs
- Connection of sensors in 2-wire technology
- Supported sensors: Pt 1000
- Data format: standardized representation
- Diagnostic information in the process data word
- Diagnostic indicator



This data sheet is only valid in association with the IL SYS INST UM E user manual.



Make sure you always use the latest documentation. It can be downloaded from the product at phoenixcontact.net/products.

2	Table of contents	
1	Description	1
2	Table of contents	2
3	Ordering data	3
4	Technical data	4
5	Temperature measuring ranges	7
6	Tolerance data.....	7
	6.1 Tolerances in 2-conductor technology at 25°C	7
	6.2 Drift response	7
	6.3 Tolerances influenced by electromagnetic interference	7
7	Internal circuit diagram	8
8	Electrical isolation.....	8
9	Terminal point assignment.....	9
10	Connection example.....	9
11	Safety note	9
12	Installation instructions	9
13	Connection notes	9
14	Local diagnostic indicator	10
15	Process data.....	10
16	Representation of measured values	10

3 Ordering data

Description	Type	Order No.	Pcs./Pkt.
Inline ECO, Temperature measurement terminal, Analog RTD inputs: 4 (Pt 1000), Connection method: 2-wire, Transmission speed in the local bus 500 kBit/s, Degree of protection IP20, including Inline connector	IB IL RTD 4/PT1000-ECO	2702501	1
Accessories	Type	Order No.	Pcs./Pkt.
Shield connection clamp, for shield on busbars, contact resistance < 1 mΩ (Assembly)	SK 8	3025163	10
Shield connection clamp, for shield on busbars, contact resistance < 1 mΩ (Assembly)	SK 14	3025176	10
Shield connection clamp, for shield on busbars, contact resistance < 1 mΩ (Assembly)	SK 20	3025189	10
Shield connection clamp, for shield on busbars, contact resistance < 1 mΩ (Assembly)	SK 35	3026463	10
Support bracket for busbars (Assembly)	AB-SK	3025341	10
Support bracket, Bracket for busbars, set every 20 cm, Length: 95.5 mm, Width: 6.2 mm, Color: gray (Assembly)	AB-SK 65	3026489	10
Support bracket, Bracket for busbars, set every 20 cm, Length: 10 mm, Width: 56 mm, Height: 20 mm, Color: silver (Assembly)	AB-SK/E	3026476	10
PEN conductor busbar, 3mm x 10 mm, length: 1000 mm (Assembly)	NLS-CU 3/10 SN 1000MM	0402174	10
Connection terminal block, Connection method Screw connection, Cross section: 0.5 mm ² - 6 mm ² , Width: 7 mm, Color: silver	AK 4	0404017	50
Connection terminal block, Connection method Screw connection, Cross section: 0.5 mm ² - 6 mm ² , Width: 7 mm, Color: green-yellow	AKG 4 GNYE	0421029	50
Connection terminal block, Connection method Screw connection, Cross section: 0.5 mm ² - 6 mm ² , Width: 7 mm, Color: black	AKG 4 BK	0421032	50
Connector, for digital 1, 2 or 8-channel Inline terminals (Connector/Adapter)	IB IL SCN-8	2726337	10
Labeling field, width: 12.2 mm (Marking)	IB IL FIELD 2	2727501	10
Shield connection terminal block, for applying the shield to busbars (Assembly)	SKS 8	3240210	10
Shield connection terminal block, for applying the shield to busbars (Assembly)	SKS 14	3240211	10
Shield connection terminal block, for applying the shield to busbars (Assembly)	SKS 20	3240212	10
Shield connection terminal block, for applying the shield directly to the conductive mounting plates (Assembly)	SKS 8-D	3240213	10

Accessories	Type	Order No.	Pcs./Pkt.
Shield connection terminal block, for applying the shield directly to the conductive mounting plates (Assembly)	SKS 14-D	3240214	10
Shield connection terminal block, for applying the shield directly to the conductive mounting plates (Assembly)	SKS 20-D	3240215	10
Shield connection terminal block, for applying the shield to busbars (Assembly)	SKS 8-NS35	3240216	10
Shield connection terminal block, for applying the shield to busbars (Assembly)	SKS 14-NS35	3240217	10
Shield connection terminal block, for applying the shield to busbars (Assembly)	SKS 20-NS35	3240218	10
Shield connection terminal block, for applying the shield to busbars (Assembly)	SKS 8-SNS35	3062786	10
Shield connection terminal block, for applying the shield to busbars (Assembly)	SKS 14-SNS35	3062799	10
Shield connection terminal block, for applying the shield to busbars (Assembly)	SKS 20-SNS35	3062809	10
Documentation	Type	Order No.	Pcs./Pkt.
User manual, English, Automation terminals of the Inline product range	IL SYS INST UM E	-	-
Data sheet, English, INTERBUS addressing	DB GB IBS SYS ADDRESS	-	-

4 Technical data

Dimensions (nominal sizes in mm)

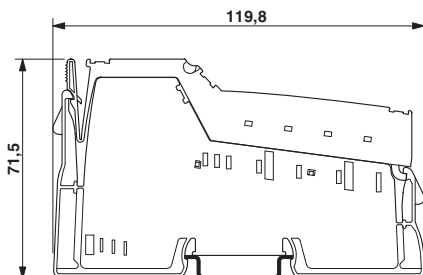

Width	12.2 mm
Height	119.8 mm
Depth	71.5 mm

General data	
Color	green
Weight	60 g (with connector)
Ambient temperature (operation)	0 °C ... 55 °C
Ambient temperature (storage/transport)	-25 °C ... 85 °C
Permissible humidity (operation)	10 % ... 95 % (according to DIN EN 61131-2)
Permissible humidity (storage/transport)	10 % ... 95 % (according to DIN EN 61131-2)
Air pressure (operation)	70 kPa ... 106 kPa (up to 3000 m above sea level)
Air pressure (storage/transport)	70 kPa ... 106 kPa (up to 3000 m above sea level)
Degree of protection	IP20
Protection class	III, IEC 61140, EN 61140, VDE 0140-1

Connection data	
Designation	Inline connector
Connection method	Spring-cage connection
Conductor cross section solid / stranded	0.08 mm ² ... 1.5 mm ² / 0.08 mm ² ... 1.5 mm ²
Conductor cross section [AWG]	28 ... 16
Stripping length	8 mm

Interface Inline local bus	
Number	2
Connection method	Inline data jumper
Transmission speed	500 kBit/s

Inline potentials / Power consumption	
Communications power U_L	7.5 V DC (via voltage jumper)
Current consumption from U_L	typ. 56 mA max. 85 mA
I/O supply voltage U_{ANA}	24 V DC
Current consumption from U_{ANA}	typ. 7.3 mA max. 14 mA
Power consumption	typ. 0.67 W max. 0.97 W

Analog RTD inputs	
Number of inputs	4 (Pt 1000)
Connection method	Inline connector
Connection method	2-wire
Sensor types (RTD) that can be used	Pt 1000 (IEC 60751/EN 60751)
Resolution A/D	24 bit
A/D conversion time	typ. 120 ms
Scan repeat time	typ. 650 ms (all four measuring channels)
Data formats	Standardized representation
Input filter	Digital filter
Input filter time	120 ms (per channel)

Analog RTD inputs	
Relative accuracy	typ. 0.2 % (of measuring range final value, at $T_A = 25^\circ\text{C}$)
Overload protection	max. ± 40 V DC, 1 min.
Transient protection	Suppressor diode
Nominal value of the current sources	210 μA (pulsed current, the data is valid during the sampling phase)

Programming Data	
ID code (hex)	7E
ID code (dec.)	126
Length code (hex)	04
Process data channel	64 Bit
Input address area	8 Byte
Output address area	0 Byte
Parameter channel (PCP)	0 Byte
Register length (bus)	64 Bit

Configuration and parameter data in a PROFIBUS system	
Required parameter data	1 Byte
Need for configuration data	4 Byte

Error messages to the higher level control or computer system	
Failure of the internal I/O supply	I/O error message sent to the bus coupler
Checksum error	I/O error message sent to the bus coupler

Electrical isolation/isolation of the voltage areas	
Test section	Test voltage
Bus logic (local bus, communications power)	500 V AC, 50 Hz, 1 min.
Analog I/O	500 V AC, 50 Hz, 1 min.
Functional earth ground	500 V AC, 50 Hz, 1 min.

Conformance with EMC Directive 2014/30/EU

Noise immunity test in accordance with EN 61000-6-2	
Electrostatic discharge (ESD) EN 61000-4-2/IEC 61000-4-2	Criterion B, 6 kV contact discharge, 8 kV air discharge
Electromagnetic fields EN 61000-4-3/IEC 61000-4-3	Criterion A, Field intensity: 10 V/m
Fast transients (burst) EN 61000-4-4/IEC 61000-4-4	Criterion B, 2 kV
Transient overvoltage (surge) EN 61000-4-5/IEC 61000-4-5	Criterion B, supply lines DC: ± 1 kV/ ± 1 kV (symmetrical/asymmetrical), shielded I/O cables: ± 1 kV
Conducted interference EN 61000-4-6/IEC 61000-4-6	Criterion A; Test voltage 10 V
Noise emission test according to EN 61000-6-3	
Radio interference properties EN 55022	Class A

Approvals
 For the latest approvals, please visit phoenixcontact.net/products.

5 Temperature measuring ranges

Supported measuring ranges			
Sensor type	Standard and manufacturer specification	Measuring range	
		Lower limit	Upper limit
Pt 1000	IEC 60751/EN 60751	-200 °C	+850 °C

6 Tolerance data

6.1 Tolerances in 2-conductor technology at 25°C

Area	Measuring range		Absolute tolerance		Relative tolerance (with reference to MRFV)	
	Lower limit	Upper limit	Typical	Maximum	Typical	Maximum
Practice	-200 °C	+400 °C	±0.8 K	±1.7 K	±0.1 %	±0.2%
Standard	-200 °C	+850 °C	±1.7 K	±3.4 K	±0.2%	±0.4%

MRFV= Measuring range final value

The relative tolerances refer to the measuring range final value of +850°C.

Typical tolerance values are measured application values that are based on the maximum variance of all test objects.

The **maximum tolerance values** represent the worst-case measurement inaccuracy. They contain the theoretical maximum possible tolerances in the corresponding measuring ranges as well as the theoretical maximum possible tolerances of the calibration and test equipment.

6.2 Drift response

Measuring range	Drift (typical)	Drift (maximum)
Pt 1000	±30 ppm/K	±100 ppm/K

6.3 Tolerances influenced by electromagnetic interference

Type of electromagnetic interference	Typical deviation in %
Electromagnetic fields	EN 61000-4-3/IEC 61000-4-3 < 1 %
Fast transients (burst)	EN 61000-4-4/IEC 61000-4-4 < 1 %
Conducted interference	EN 61000-4-6/IEC 61000-4-6 < 1 %

The typical deviation refers to the measuring range final value.

7 Internal circuit diagram

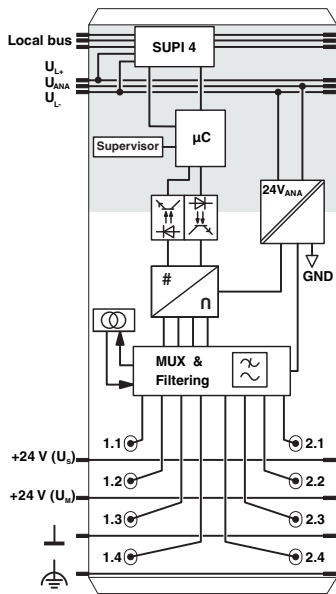



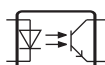







Figure 1 Internal wiring of the terminal points

Key:

	Protocol chip
	Microprocessor
	Hardware monitoring
	Optocoupler
	Power supply unit with electrical isolation
	Analog-digital converter with integrated multiplexer
	Current source for the sensor supply
	Low pass filter
	Electrically isolated area

8 Electrical isolation

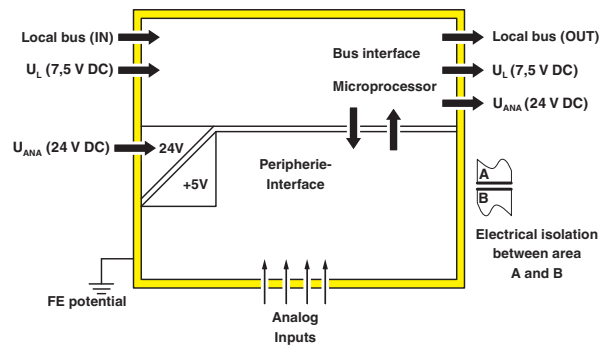

Figure 2 Electrical isolation of the individual function areas

9 Terminal point assignment

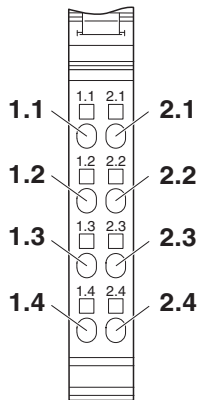

Figure 3 Terminal point assignment

Terminal point	Signal	Description	Channel
1.1	IN01+	RTD input	1 +
1.2	IN01-	RTD input	1 -
1.3	IN02+	RTD input	2 +
1.4	IN02-	RTD input	2 -
2.1	IN03+	RTD input	3 +
2.2	IN03-	RTD input	3 -
2.3	IN04+	RTD input	4 +
2.4	IN04-	RTD input	4 -

10 Connection example

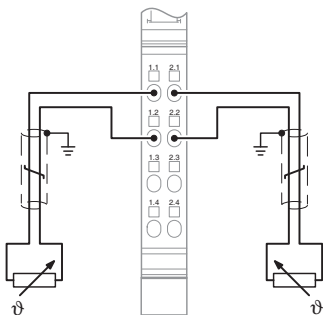

Figure 4 Connecting the sensors

11 Safety note



WARNING: Electric shock

During configuration, ensure that no isolating voltage for safe isolation is specified between the analog inputs and the bus. This means that the user has to provide signals with safe isolation, if applicable.

12 Installation instructions

High current flowing through potential jumpers U_M and U_S leads to a temperature rise in the potential jumpers and inside the terminal. To keep the current flowing through the potential jumpers of the analog terminals as low as possible, always place the analog terminals after all the other terminals at the end of the main circuit (for the sequence of the Inline terminals: see also IL SYS INST UM E user manual).

13 Connection notes

Always connect the analog sensors using shielded, twisted pair cables.

Use cable LiYCY n*2*0.5 mm², for example. The larger the conductor cross section, the fewer measuring errors due to the cable resistance.

For optimum accuracy, always connect channel 1. If channel 1 is not connected, short circuit it.

Connect the shielding with the shielding accessories given in the ordering data.

14 Local diagnostic indicator

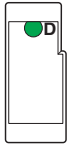

Figure 5 Local diagnostic indicator

Designation	Color	Meaning
D	green	Diagnostics (bus and logic voltage)



For detailed information on diagnostics, please refer to the IL SYS INST UM E user manual.

15 Process data

The terminal uses four words of IN process data.

Each channel is mapped to a word.

The measured values are transmitted to the controller board or the computer using process data input words.

Order of the process data words

Word	0	1	2	3
Channel	1	2	3	4

The measured values are depicted in standardized representation format.

In this format, data is standardized to the measuring range and represented in such a way that it indicates the corresponding value without conversion.

The measured value is represented in bits 14 to 0. An additional bit (bit 15) is available as a sign bit.

15	14	13	12	11	10	9	8	7	6	5	4	3	2	1	0
V	Analog value														

V Sign bit

In standardized representation format, a diagnostic code is mapped to the input data in the event of an error.

Code (hex)	Cause
8001	Measuring range exceeded (overrange)
8002	Open circuit
8004	Measured value invalid or no valid measured value available
8010	Parameter table invalid
8020	Faulty supply voltage
8040	Device faulty
8080	Below measuring range (underrange)

16 Representation of measured values

Input data		Temperature
hex	dec	°C
8001	Measuring range exceeded (overrange)	> upper limit value
03E8	1000	+100.0
0001	1	+0.1
0000	0	0
FFFF	-1	-0.1
FC18	-1000	-100.0
8080	Below measuring range (underrange)	< lower limit value