

IB IL RS 485-ECO

Inline ECO communication terminal for serial data transmission (RS-485)

Data sheet
106679_en_03

© PHOENIX CONTACT 2016-11-03

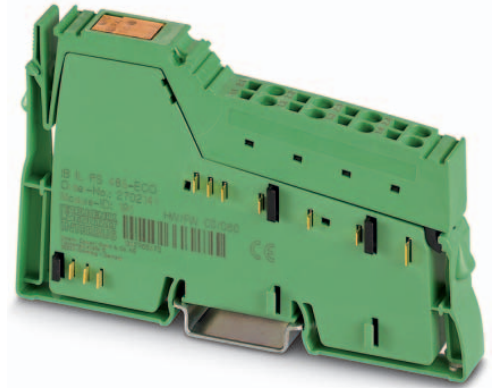

1 Description

The terminal is designed for use within an Inline station. The terminal is used to operate standard I/O devices with serial interfaces on a bus system. Inline ECO terminals are approved for the temperature range from 0°C to +55°C. The electronics base and Inline connector are supplied as standard.

Features

- One serial input and output channel in RS-485 format
- Data is transmitted in transparent mode
- Transmission speeds can be set up to 38400 Baud
- Number of data bits, stop bits and parity can be set
- Parameterization via process data
- Diagnostic and status indicators



This data sheet is only valid in association with the IL SYS INST UM E user manual.



Make sure you always use the latest documentation. It can be downloaded from the product at phoenixcontact.net/products.

2	Table of contents	
1	Description	1
2	Table of contents	2
3	Ordering data	3
4	Technical data	4
5	Internal circuit diagram	6
6	Electrical isolation.....	6
7	Terminal point assignment.....	7
8	Local diagnostic and status indicators	7
9	Connection note	7
10	Connection examples	8
	10.1 RS-485: Terminal as the network end point	8
	10.2 RS-485: Terminal in the network center	8
11	RS-485 serial interface	8
12	Mass storage and transmission	8
	12.1 Supported protocols	8
	12.2 Transparent protocol	8
13	Process data.....	9
	13.1 Control word.....	10
	13.2 Status word.....	11
14	Commands	12
	14.1 "Read number of characters received" command	12
	14.2 "Transmit characters" command	12
	14.3 "Store characters temporarily" command	13
	14.4 "Read characters" command	13
	14.5 "Read counters" command	13
	14.6 "Read firmware version" command.....	13
	14.7 "Write configuration" command	14

3 Ordering data

Description	Type	Order No.	Pcs./Pkt.
Inline ECO communication terminal, for serial data transmission, 1 serial input and output channel in RS-485 format, with connector plug	IB IL RS 485-ECO	2702141	1
Accessories			
Connector, for digital 1, 2 or 8-channel Inline terminals (Connector/Adapter)	IB IL SCN-8	2726337	10
Inline shield connector (Connector/Adapter)	IB IL SCN-6 SHIELD	2726353	5
Labeling field, width: 12.2 mm (Marking)	IB IL FIELD 2	2727501	10
Insert strip, Sheet, white, unlabeled, can be labeled with: Office printing systems, Plotter: Laser printer, Mounting type: Insert, Lettering field: 62 x 10 mm (Marking)	ESL 62X10	0809492	1
Shield connection clamp, for shield on busbars, contact resistance < 1 mΩ (Assembly)	SK 8	3025163	10
Shield connection clamp, for shield on busbars, contact resistance < 1 mΩ (Assembly)	SK 14	3025176	10
Shield connection clamp, for shield on busbars, contact resistance < 1 mΩ (Assembly)	SK 20	3025189	10
Shield connection clamp, for shield on busbars, contact resistance < 1 mΩ (Assembly)	SK 35	3026463	10
Support bracket for busbars (Assembly)	AB-SK	3025341	10
Support bracket, Bracket for busbars, set every 20 cm, Length: 95.5 mm, Width: 6.2 mm, Color: gray (Assembly)	AB-SK 65	3026489	10
Support bracket, Bracket for busbars, set every 20 cm, Length: 10 mm, Width: 56 mm, Height: 20 mm, Color: silver (Assembly)	AB-SK/E	3026476	10
PEN conductor busbar, 3mm x 10 mm, length: 1000 mm (Assembly)	NLS-CU 3/10 SN 1000MM	0402174	10
Connection terminal block, Connection method Screw connection, Cross section: 0.5 mm ² - 6 mm ² , Width: 7 mm, Color: silver	AK 4	0404017	50
Connection terminal block, Connection method Screw connection, Cross section: 0.5 mm ² - 6 mm ² , Width: 7 mm, Color: green-yellow	AKG 4 GNYE	0421029	50
Connection terminal block, Connection method Screw connection, Cross section: 0.5 mm ² - 6 mm ² , Width: 7 mm, Color: black	AKG 4 BK	0421032	50
Documentation			
User manual, English, Automation terminals of the Inline product range	IL SYS INST UM E	-	-
Data sheet, English, INTERBUS addressing	DB GB IBS SYS ADDRESS	-	-

4 Technical data

Dimensions (nominal sizes in mm)

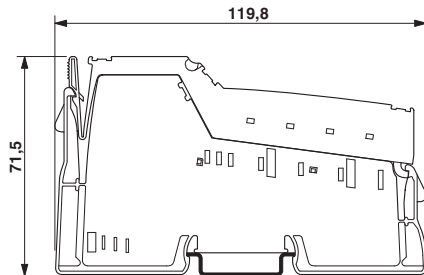

Width	12.2 mm
Height	119.8 mm
Depth	71.5 mm

General data

Color	green
Mounting type	DIN rail
Ambient temperature (operation)	0 °C ... 55 °C
Ambient temperature (storage/transport)	-25 °C ... 85 °C
Permissible humidity (operation)	10 % ... 95 % (according to DIN EN 61131-2)
Permissible humidity (storage/transport)	10 % ... 95 % (according to DIN EN 61131-2)
Air pressure (operation)	70 kPa ... 106 kPa (up to 3000 m above sea level)
Air pressure (storage/transport)	70 kPa ... 106 kPa (up to 3000 m above sea level)
Degree of protection	IP20
Protection class	III, IEC 61140, EN 61140, VDE 0140-1

Connection data

Designation	Inline connector
Connection method	Spring-cage connection
Conductor cross section solid / stranded	0.08 mm ² ... 1.5 mm ² / 0.08 mm ² ... 1.5 mm ²
Conductor cross section [AWG]	28 ... 16
Stripping length	8 mm

Interface Inline local bus

Connection method	Inline data jumper
Transmission speed	500 kbps

Interface RS-485

Connection method	Spring-cage connection
Transmission speed	110 Bit/s ... 38400 Bit/s (configurable)
Transmission physics	Copper

Interface RS-485

Input buffer	4 kByte
Output buffer	1 kByte
Data bits	6 ... 8
Stop bits	1 or 2

Power consumption

Communications power U_L	7.5 V (via voltage jumper)
Current consumption from U_L	typ. 70 mA max. 85 mA
Power consumption	typ. 525 mW (at U_L)



This terminal takes no current from potential jumpers U_M , U_S , and U_{ANA} .

Programming Data

ID code (hex)	BF
ID code (dec.)	191
Length code (hex)	07
Length code (dec.)	07
Process data channel	112 Bit
Input address area	14 Byte
Output address area	14 Byte
Parameter channel (PCP)	0 Byte
Register length	112 Bit

Electrical isolation/isolation of the voltage areas

Test section	Test voltage
Serial interface/7.5 V supply (bus logic)	500 V AC, 50 Hz, 1 min.
Serial interface/24 V supply U_M	500 V AC, 50 Hz, 1 min.
Serial interface/functional earth ground	500 V AC, 50 Hz, 1 min.
7.5 V supply (bus logics) / functional earth ground	500 V AC, 50 Hz, 1 min.
24 V supply (U_M)/functional earth ground	500 V AC, 50 Hz, 1 min.

Error messages to the higher level control or computer system

None

Approvals

For the latest approvals, please visit phoenixcontact.net/products.

5 Internal circuit diagram

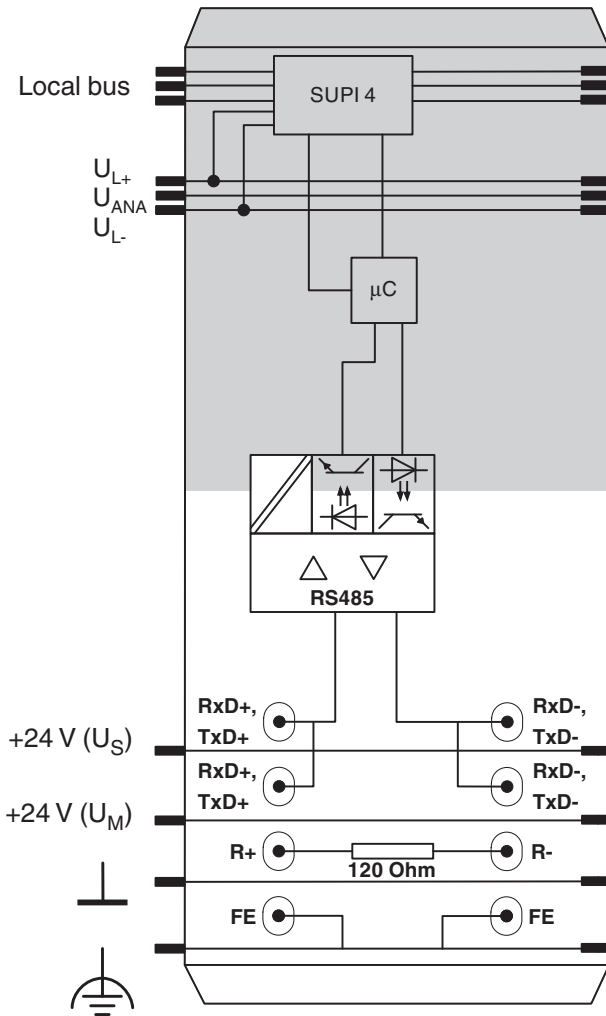
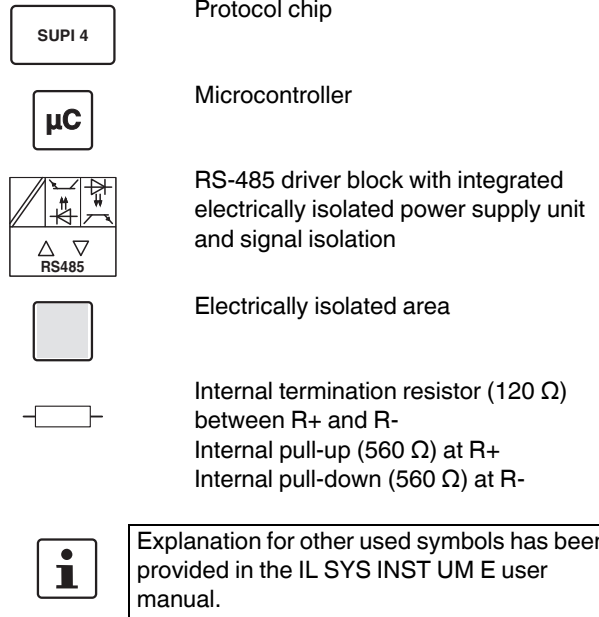

Figure 1 Internal wiring of the terminal points

Key:



6 Electrical isolation

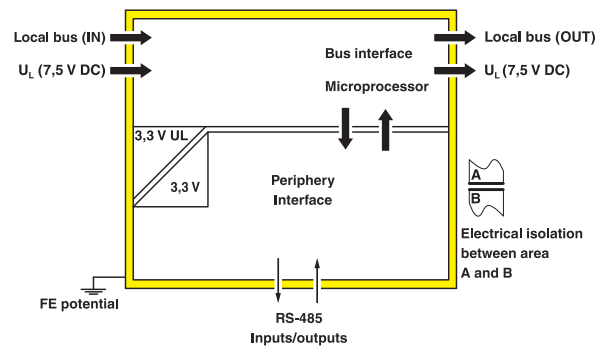

Figure 2 Electrical isolation of the individual function areas

7 Terminal point assignment

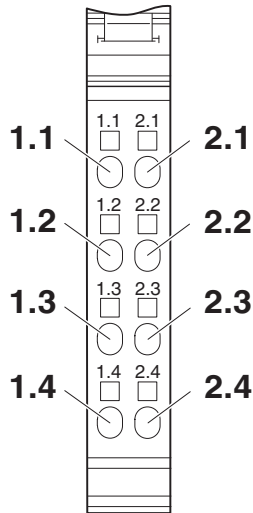

Figure 3 Terminal point assignment

Terminal point	Signal	Description	
1.1	RxD+, TxD+	Receive/transmit data	positive
2.1	RxD-, TxD-	Receive/transmit data	negative
1.2	RxD+, TxD+	Receive/transmit data	positive
2.2	RxD-, TxD-	Receive/transmit data	negative
1.3	R+	Termination resistor	Positive pole
2.3	R-	Termination resistor	Negative pole
1.4, 2.4	Shield	Shield connection, same potential as FE	



Terminal points 1.1 and 1.2 are jumpered internally in the device, as are terminal points 2.1 and 2.2.

8 Local diagnostic and status indicators



Figure 4 Local diagnostic and status indicators

Designation	Color	Meaning
D	Green	Diagnostics (bus and logic voltage)
RxD	Yellow	Terminal receives data from the connected device
TxD	Yellow	Terminal transmits data to the connected device



For detailed information on diagnostics, please refer to the IL SYS INST UM E user manual.

Function identification

Orange

9 Connection note

In order to increase noise immunity, Phoenix Contact recommends connecting the shield on both sides.

10 Connection examples

Special feature	Notes
Inline terminal as network end point	Termination resistor required
Terminal in the network center	Termination resistor not required



Connect the shielding with the shielding accessories given in the ordering data.

10.1 RS-485: Terminal as the network end point



Fit a termination resistor to the RS-485 network at each endpoint.

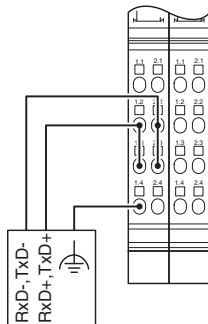

Figure 5 Inline terminal as network end point

10.2 RS-485: Terminal in the network center

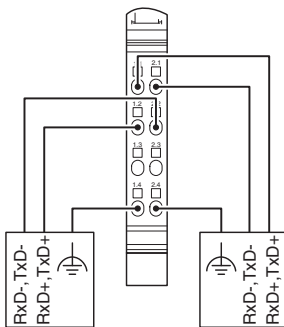

Figure 6 Inline terminal in the network center

11 RS-485 serial interface

With RS-485, you can create a network with several devices using an existing network consisting of two signal lines.

Use a twisted-pair, shared and shielded data line to connect the devices. Fit this data line with termination resistors at the two most remote points of the RS-485 network. Use the termination resistor integrated in the device when connecting the Inline terminal.

Only half duplex transmission is supported. Make sure that data is not sent simultaneously by several devices.

To ensure a defined idle cable state, the terminal contains data line polarization.

12 Mass storage and transmission

The terminal stores the received serial data in an intermediate buffer until it is requested from the serial interface by the bus controller board or the device. Serial data traffic is processed according to the transparent protocol.

12.1 Supported protocols

Protocol	Receive memory	Transmit memory	Special features when receiving
Transparent	4096 bytes	1023 bytes	

12.2 Transparent protocol

If the transparent protocol is used, serial data is transmitted in the same format it is received from the serial interface or from the bus side.

The transmit FIFO (first-in, first-out memory) can store 1023 bytes (1 kbyte) and the receive FIFO can store 4096 bytes (4 kbytes). If the terminal receives another character after the 4095th character, the error pattern is stored in the receive FIFO. All other subsequent characters are ignored.

13 Process data

The module uses seven words of IN process data and seven words of OUT process data.



For the assignment of the illustrated (byte.bit) view to your INTERBUS control or computer system, please refer to the DB GB IBS SYS ADDRESS data sheet.

Word	0		1		2		3		4		5		6	
Byte in the Motorola format	0	1	2	3	4	5	6	7	8	9	10	11	12	13
Byte in the Intel format	1	0	3	2	5	4	7	6	9	8	11	10	13	12
OUT	Control word		L	D	D	D	D	D	D	D	D	D	D	D
	K/P	S												
IN	Status word		L	D	D	D	D	D	D	D	D	D	D	D
	K/P	S												

- K/P Command/parameter
- S Control bits (OUT) or status bits (IN)
- L Length: Number of characters to be written (OUT) or to be read (IN)
- D Data



The byte representation in the Motorola format, also called Big Endian (high order byte at starting address) corresponds to the INTERBUS standard representation. All byte representations in the data sheet have this format.

The byte representation in the Intel format is also called Little Endian (low order byte at starting address).

The command is used to determine the function. The actually transmitted data depends on the command.

13.1 Control word

OUT0															
15	14	13	12	11	10	9	8	7	6	5	4	3	2	1	0
0	Command			OUT parameter											

Commands and OUT parameters

Bit 15	Code (bin)	Code (hex)	Command and OUT parameter
	Bit 14 ... 12	Bit 15 ... 12	
0	000	0	Read number of characters received
0	001	1	Transmit characters
0	010	2	Store characters temporarily
0	011	3	OUT parameter = 0 _{hex} : Read characters
			OUT parameter = C _{hex} : Read firmware version
			OUT parameter = D _{hex} : Read configuration
			OUT parameter = E _{hex} : Read counters
0	100	4	Write configuration
0	101	5	Toggle command 1: Transmit characters
0	110	6	Toggle command 2: Store characters temporarily
0	111	7	Toggle command 3: Read characters

Command toggling

Command toggling is used to execute a command on a terminal again. In this way, a second command code is available for the same function.

This applies for the following commands:

- Transmit characters
- Store characters temporarily
- Read characters

Here, bit 14 is used for toggling. If, for example, you wish to transmit character strings in sequence, use command code 001_{bin} for the first transmission and then use 101_{bin} and 001_{bin} alternately.

13.2 Status word

INO															
15	14	13	12	11	10	9	8	7	6	5	4	3	2	1	0
St	Command			IN parameter				Status bits							

St Error bit

Reasons for an error bit set:

- Invalid parameter for the specified command
- For transmit command: incorrect length

Status bits

7	6	5	4	3	2	1	0
0	Transmit buffer not empty	Transmit buffer full	Receive buffer full	0	0	0	Receive buffer not empty

Transmit buffer not empty	
Code (bin)	Meaning
0	Empty
1	Not empty, characters to be sent are still available

Transmit buffer full	
Code (bin)	Meaning
0	Not full
1	Full

Receive buffer full	
Code (bin)	Meaning
0	Not full
1	Full

Code (bin)	Meaning
Receive buffer not empty	
0	Empty
1	Not empty, characters to be read are available

14 Commands

14.1 "Read number of characters received" command

The command result is the number of characters that have been received but not yet read.

This command can be used to first reach a minimum number of characters before transmitting the "Read characters" command.

The number is a 16-bit value and is mapped to word 1.

Process data assignment for the "Read number of characters received" command (process data width: 7 words)

Word	0		1		2		3		4		5		6	
Byte	0	1	2	3	4	5	6	7	8	9	10	11	12	13
OUT	00 _{hex}	xx	xx	xx	xx	xx	xx	xx	xx	xx	xx	xx	xx	xx
IN	00 _{hex}	Status bits	Number of characters received		xx	xx	xx	xx	xx	xx	xx	xx	xx	xx

14.2 "Transmit characters" command

The transmit data located in the process data is stored in the transmit memory. From there the data is transmitted directly via the interface.

A maximum of eleven characters can be transmitted.

Specify the number of characters to be transmitted in the third byte.

If there are characters in the intermediate buffer, these are transmitted first.

After the command has been executed successfully, the intermediate buffer is cleared.

Process data assignment for the "Transmit characters" command with 11 characters (Z1 - Z11; process data width: 7 words)

Word	0		1		2		3		4		5		6	
Byte	0	1	2	3	4	5	6	7	8	9	10	11	12	13
OUT	10 _{hex}	xx	0B _{hex}	Z1	C2	C3	C4	C5	C6	C7	C8	C9	C10	C11
IN	10 _{hex}	Status bits	xx	xx	xx	xx	xx	xx	xx	xx	xx	xx	xx	xx

Reasons for an error bit set:

- Byte 2 (number of characters to be transmitted)
= 0 or > maximum user data length (11 characters)

14.3 "Store characters temporarily" command

If more than 11 characters are to be transmitted, the transmit data located in the process data is stored in an intermediate buffer which can store up to 330 characters. No characters are transmitted. The "Transmit characters" command is used to transmit temporarily stored data. In this way, blocks of up to 330 characters can be transmitted without a break. They are divided over 30 telegrams with 11 characters each, for example.

Reasons for an error bit set:

- Byte 2 (number of characters to be transmitted) = 0 or > maximum user data length (11 characters)
- Not enough space in the intermediate buffer

14.4 "Read characters" command

A maximum of eleven characters can be read.

Process data assignment for the "Read characters" command with eleven characters (C1 - C11)

Word	0		1		2		3		4		5		6	
Byte	0	1	2	3	4	5	6	7	8	9	10	11	12	13
OUT	30 _{hex}	xx	xx	xx	xx	xx	xx	xx	xx	xx	xx	xx	xx	xx
IN	30 _{hex}	Status bits	0B _{hex}	Z1	C2	C3	C4	C5	C6	C7	C8	C9	C10	C11

14.5 "Read counters" command

This command can be used to read several counters. The counters are used for interface diagnostics.

Process data assignment for the "Read counters" command

Word	0		1		2		3		4		5		6	
Byte	0	1	2	3	4	5	6	7	8	9	10	11	12	13
OUT	3E _{hex}	00 _{hex}	xx	xx	xx	xx	xx	xx	xx	xx	xx	xx	xx	xx
IN	3E _{hex}	Status bits	Number of valid characters received		Number of invalid characters received (parity, overrun or framing errors)		Number of characters transmitted		xx	xx	xx	xx	xx	xx

14.6 "Read firmware version" command

For control word 3C00_{hex}, word IN1 supplies the firmware version and the module ID.

Example: Firmware version 1.23

Word	IN1															
Bit	15	14	13	12	11	10	9	8	7	6	5	4	3	2	1	0
Assignment (hex)	1				2				3				7			
Meaning	Firmware version												Module ID			

14.7 "Write configuration" command

Output words 0 to 6

Process data assignment for the "Write configuration" command

Word	0		1		2		3		4		5		6	
Byte	0	1	2	3	4	5	6	7	8	9	10	11	12	13
OUT	40 _{hex}	xx	res.	B/DB	res.	res.	ErrP	res.	res.	res.	res.	res.	res.	res.
IN	40 _{hex}	Status bits	-	-	-	-	-	-	-	-	-	-	-	-

Element value range



The options in bold are default settings.

Byte 3 (B/DB: baud rate/data width)

Baud rate	
Code (hex)	Wert (baud)
0	110
1	300
2	600
3	1200
4	1800
5	2400
6	4800
7	9600
8	15625
9	19200
A	38400
Other	Reserved

Code (hex)	Data width		
	Data bits	Parity	Stop bits
0	7	Even	1
1	7	Odd	1
2	8	Even	1
3	8	Odd	1
4	8	Without	1
5	7	Without	1
6	7	Even	2
7	7	Odd	2
8	8	Even	2
9	8	Odd	2
A	8	Without	2
B	7	Without	2
C	8	Constantly at 0	1
D	8	Constantly at 1	1
E	6	Without	1
F	Reserved		

Byte 6 (ErrP: error pattern)

The error pattern contains the character that is written to the FIFO if a character was received with errors (e.g., in the event of a parity error) or the receive memory is full.

Error pattern	
Code (hex)	Meaning
24	\$
xx	Any character
00	If a character is received with an error, no error pattern is stored.
FF	The invalid character is stored instead of the error pattern.